



ZORZINI

MADE IN ITALY

GOULD STOCK MANWAYS



GOULD STAINLESS PRODUCTS LTD.
www.gouldstainless.com

1141, 6027 - 79 STREET SE
CALGARY, AB T2C 5P1
CANADA

PHONE: (403) 640-2331
TOLL FREE: (866) 477-5831
E-MAIL: trentc@gouldstainless.com

ZORZINI MANWAYS - GOULD STOCK CATALOGUE

Since 1991, **Gould Stainless Product Ltd.** has been a leading wholesale importer and distributor supplying the wine, brewing, distilling, beverage, dairy, manufacturing and other industries. Our extensive range and inventory includes:

Sanitary Stainless:

- Tube (*Polished ID/OD*)
- Fittings (*Tri-clamp, Butt-weld, Adapters, Bevel Seat, DIN 11851 and SMS*)
- Tank Manways & Doors
- Tank Components (*Vents, PRV's, Upper/Lower Level Gauges, Sample Valves*)
- Tank Cleaning Components (*Spray Balls & Rotary Washers*)
- Process Components (*Butterfly, Ball, Check & Sample Valves, Sight Glasses & Filters*)
- Sparge Components (*Carbonation Stones and Oxygen Sight Glass*)
- Connection Gaskets (*Various sizes, connection types and materials*)

Industrial Stainless:

- Ball Valves (*1-piece, 2-piece and 3-piece*)
- NPT Fittings
- Camlock Fittings

Gould Stainless Products Ltd. ships to all locations with-in Canada and the USA, international shipping can be arranged as well. With a commitment to keeping a large inventory allows us to ship the same day on most orders.



Table of Contents

TABLE OF CONTENTS	
OVAL MANWAYS	5
MODEL 170	5
MODEL 174/AE	5
MODEL 184	5
MODEL 186	5
MODEL 190	6
MODEL 191	6
MODEL 203	6
MODEL 201LZD	6
MODEL 200/R	7
MODEL 200/RP	7
MODEL 630	7
MODEL 631	7
ROUND FRONT MANWAYS	8
MODEL 210	8
MODEL 211	8
MODEL 220	8
MODEL 521	8
RECTANGULAR MANWAYS	9
MODEL Z/175	9
MODEL 295	9
MODEL 160	9
MODEL 165	9
MODEL 166	10
MODEL 1500	10
MODEL 1502	10
MODEL 1600	10
MODEL 1601	11
MODEL 1602	11
MODEL 1603	11
MODEL 1702	11

ROUND TOP 8.0" MANWAYS	12
MODEL 230	12
MODEL 235	12
MODEL N/230	12
MODEL T1/200	12
ROUND TOP 12.0" MANWAYS	13
MODEL 240	13
MODEL 241	13
MODEL T1/300	13
MODEL T1/301	13
ROUND TOP 16.0" MANWAYS	14
MODEL 250	14
MODEL N/240	14
MODEL N/250	14
MODEL NL/250	14
MODEL TV/400	15
MODEL TV/401	15
MODEL T1/400 & T1/401	15
MODEL 6V/250	15
ROUND TOP 18.0" MANWAYS	16
MODEL TV/450	16
MODEL T1/450	16
MODEL T/450	16
MODEL 5V/450	16
ROUND TOP 20.0" MANWAYS	17
MODEL N/270	17
MODEL TV/500	17
MODEL T1/500	17
MODEL T/500	17
MODEL 6V/500	18
ROUND TOP 24.0" MANWAYS	19
MODEL TV/600	19
MODEL T1-600	19

MODEL T/600	19
MODEL 8V/600	19
ROUND TOP 31.5" MANWAYS	20
MODEL T1/800	20
MODEL 10V/800	20
ROUND TOP 35" MANWAYS	21
MODEL D14-900	21
ROUND TOP 47" MANWAYS	21
MODEL D14-1200	21
ROUND GLASS TOP MANWAYS	22
MODEL T1/G400	22
MODEL T1/G450	22
MODEL T1/G500	22
ROUND LIGHT PRESSURE MANWAYS	23
MODEL 300L/E	23
MODEL 400L/E	23
MODEL 450L/E	23
MODEL 500L/E	23
MODEL 600L/E	24
SAFETY GRATES	25
MANWAY FINISH CHART	26
HANDLES	27
GASKETS	30

OVAL MANWAYS

ZORZINI MODEL 170



Description	Oval Manway - Opening Inwards
Model No.:	170
Dimensions:	440mm x 320mm (17.0" x 13.0")
Weld Neck Length:	60mm (2.36")
Working Pressure:	1.3 BAR (18.8 PSI)
Handle Type:	MEC/80
Gasket Material:	EPDM - G/170
Weight:	6.4 kg (14.1 lb.)
Stocked In:	304L

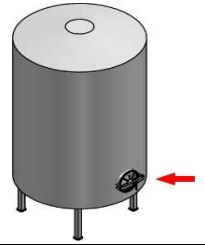

ZORZINI MODEL 174/AE



Description	Oval Manway - Opening Outwards
Model No.:	174/AE
Dimensions:	440mm x 320mm (17.0" x 13.0")
Weld Neck Length:	60mm (2.36")
Working Pressure:	0.1 BAR (1.4 PSI)
Handle Type:	MEC/80-INOX SS
Gasket Material:	EPDM - G/170
Weight:	11.5 kg (25.3 lb.)
Stocked In:	304L

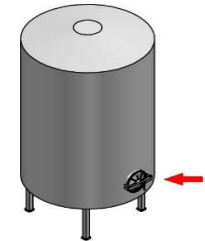

ZORZINI MODEL 184



Description	Oval Manway - Opening Inwards
Model No.:	184
Dimensions:	440mm x 320mm (17.0" x 13.0")
Weld Neck Length:	60mm (2.36")
Working Pressure:	1.3 BAR (18.8 PSI)
Handle Type:	MEC/80-INOX SS
Gasket Material:	EPDM - G/170
Weight:	9.2 kg (20.3 lb.)
Stocked In:	304L & 316L

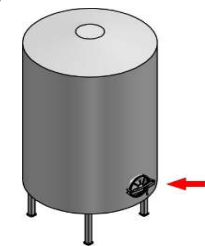

ZORZINI MODEL 186



Description	Oval Manway - Opening Inwards
Model No.:	186
Dimensions:	440mm x 320mm (17.0" x 13.0")
Weld Neck Length:	80mm (3.14")
Working Pressure:	1.3 BAR (18.8 PSI)
Handle Type:	MEC/80-INOX SS
Gasket Material:	EPDM - G/170
Weight:	10.7 kg (23.6 lb.)
Stocked In:	304L & 316L

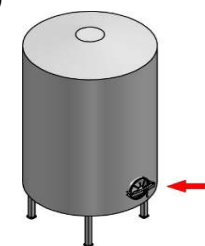

OVAL MANWAYS

ZORZINI MODEL 190



Description	Oval Manway - Opening Inwards & Outwards
Model No.:	190
Dimensions:	542mm x 446mm (21.5" x 17.5")
Weld Neck Length:	76mm (3.00")
Working Pressure:	2.8 BAR (40.6 PSI)
Handle Type:	V1/190
Gasket Material:	EPDM - G/480
Weight:	13.0 kg (28.7 lb.)
Stocked In:	304L & 316L

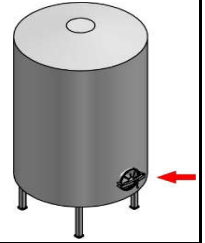

ZORZINI MODEL 191



Description	Oval Manway - Opening Inwards & Outwards
Model No.:	191
Dimensions:	582mm x 492mm (22.9" x 19.3")
Weld Neck Length:	195mm (7.67")
Working Pressure:	2.8 BAR (40.6 PSI)
Handle Type:	V1/190
Gasket Material:	EPDM - G/480
Weight:	19.2 kg (42.3 lb.)
Stocked In:	304L

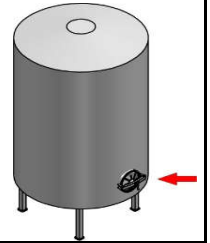

ZORZINI MODEL 203



Description	Oval Manway - Opening Inwards & Outwards
Model No.:	203
Dimensions:	490mm x 395mm (19.25" x 15.5")
Weld Neck Length:	100mm (3.93")
Working Pressure:	2.7 BAR (39.1 PSI)
Handle Type:	V1/190
Gasket Material:	EPDM - G/15
Weight:	20.8 kg (45.9 psi)
Stocked In:	304L

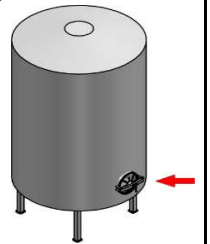

ZORZINI MODEL 201LZD



Description	Oval Manway - Opening Inwards & Outwards
Model No.:	201LZD
Dimensions:	532mm x 432mm (21.0" x 17.0")
Weld Neck Length:	100mm (3.93")
Working Pressure:	4.8 BAR (69.6 PSI)
Handle Type:	V1/190
Gasket Material:	EPDM - G/200/LZD
Weight:	24.0 kg (52.9 lb.)
Stocked In:	304L & 316L

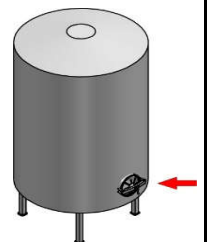

OVAL MANWAYS

ZORZININ MODEL 200/R



Description	Oval Manway - Opening Inwards & Outwards
Model No.:	200/R (Shadowless Manway)
Dimensions:	540mm x 440mm (22.0" x 17.5")
Weld Neck Length:	40mm x 15mm (1.57" x 0.59")
Working Pressure:	2.8 BAR (40.6 PSI)
Handle Type:	V1/190
Gasket Material:	EPDM - G/200/R
Weight:	15.2 kg (33.5 lb.)
Stocked In:	304L *Call to see about sizes in stock*

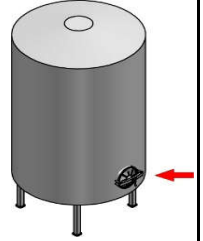

ZORZININ MODEL 200/RP



Description	Oval Manway - Opening Inwards & Outwards
Model No.:	200/RP (Shadowless Manway)
Dimensions:	510mm x 370mm (20.0" x 14.5")
Weld Neck Length:	30mm x 15mm (1.18" x 0.59")
Working Pressure:	3.2 BAR (46.4 PSI)
Handle Type:	V1/165
Gasket Material:	EPDM - G/200/RP
Weight:	10.5 kg (23.2 lb.)
Stocked In:	304L *Call to see about sizes in stock*

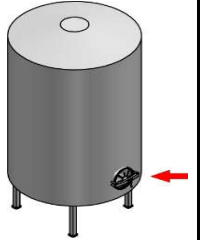

ZORZININ MODEL 630



Description	Oval Manway - Opening Inwards & Outwards
Model No.:	630
Dimensions:	658mm x 532mm (25.9" x 20.9")
Weld Neck Length:	100mm (3.93")
Working Pressure:	4.0 BAR (58.0 PSI)
Handle Type:	V1/260
Gasket Material:	EPDM - G/630
Weight:	38.0 kg (83.8 lb.)
Stocked In:	304L & 316L

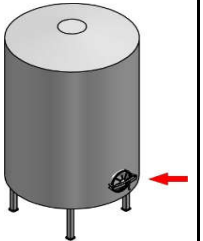

ZORZININ MODEL 631



Description	Oval Manway - Opening Inwards & Outwards
Model No.:	631
Dimensions:	658mm x 532mm (25.9" x 20.9")
Weld Neck Length:	160mm (6.30")
Working Pressure:	4.0 BAR (58.0 PSI)
Handle Type:	V1/260
Gasket Material:	EPDM - G/630
Weight:	49.0 kg (108.0 lb.)
Stocked In:	304L

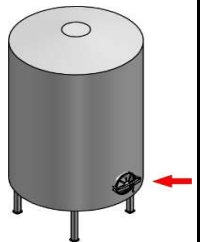

ROUND MANWAYS

ZORZINI MODEL 210



Description	Round Manwaydoor, Opening Outwards
Model No.:	210
Dimensions:	306mm (12.0")
Weld Neck Length:	65 (2.55)
Working Pressure:	0.2 BAR (2.90 PSI)
Handle Type:	MEC/151
Gasket Material:	EPDM - G/TR300
Weight:	3.6 kg (7.9 lb.)
Stocked In:	304L

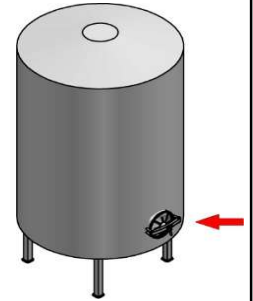

ZORZINI MODEL 211



Description	Round Manwaydoor, Opening Outwards
Model No.:	211
Dimensions:	306mm (12.0")
Weld Neck Length:	100mm (3.93")
Working Pressure:	0.2 BAR (2.90 PSI)
Handle Type:	MEC/151
Gasket Material:	EPDM - G/TR300
Weight:	4.0 kg (8.8 lb.)
Stocked In:	304L

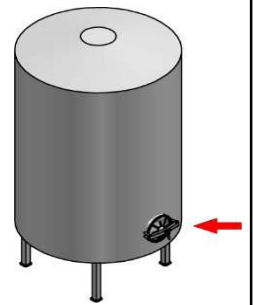

ZORZINI MODEL 220



Description	Round Manwaydoor, Opening Outwards
Model No.:	220
Dimensions:	418mm (16.5")
Weld Neck Length:	60mm (2.36")
Working Pressure:	0.6 BAR (8.7 PSI)
Handle Type:	V1/200
Gasket Material:	EPDM - G/AE
Weight:	11.8 kg (26.0 lb.)
Stocked In:	304L

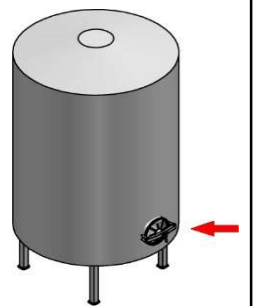

ZORZINI MODEL 521



Description	Round Manwaydoor, Opening Outwards
Model No.:	521
Dimensions:	542mm (21.5")
Weld Neck Length:	100mm (3.93")
Working Pressure:	1.0 BAR (14.5 PSI)
Handle Type:	V1/165/A
Gasket Material:	EPDM - G/TR500
Weight:	33.0 kg (72.7 lb.)
Stocked In:	304L

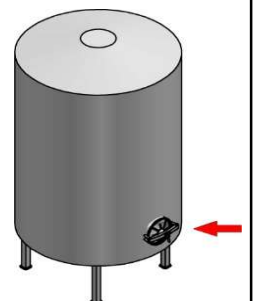

RECTANGULAR MANWAYS

ZORZINI MODEL Z/175



Description Rectangular Manwaydoor, Opening Outwards
Model No.: Z/175
Dimensions: 300mm x 165mm (12" x 6.5")
Weld Neck Length: 60mm (2.36")
Working Pressure: 0.5 BAR (7.25 PSI)
Handle Type: MEC/80/A
Gasket Material: EPDM - G/175
Weight: 4.8 kg (10.6 lb.)
Stocked In: 304L

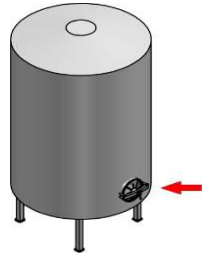

ZORZINI MODEL 295



Description Rectangular Manwaydoor, Opening Outwards
Model No.: 295
Dimensions: 235mm x 185mm (9.25" x 7.25")
Weld Neck Length: 40mm (1.57")
Working Pressure: 0.5 BAR (7.25 PSI)
Handle Type: MEC/60/A
Gasket Material: EPDM - G/295
Weight: 3.2 kg (7.0 lb.)
Stocked In: 304L

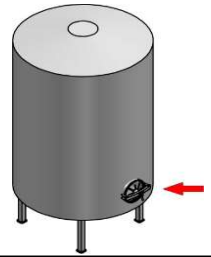

ZORZINI MODEL 160



Description Rectangular Manwaydoor, Opening Outwards
Model No.: 160
Dimensions: 332mm x 440mm (13.0" x 17.5")
Weld Neck Length: 60mm (2.36")
Working Pressure: 0.5 BAR (7.25 PSI)
Handle Type: V1/165/A
Gasket Material: EPDM - G/R165
Weight: 11.5 kg (25.3 lb.)
Stocked In: 304L

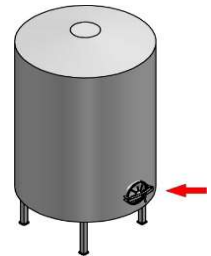

ZORZINI MODEL 165



Description Rectangular Manwaydoor, Opening Outwards
Model No.: 165
Dimensions: 440mm x 332mm (17.5" x 13.0")
Weld Neck Length: 60mm (2.36")
Working Pressure: 0.5 BAR (7.25 PSI)
Handle Type: V1/165/A
Gasket Material: EPDM - G/R165
Weight: 12.6 kg (27.8 lb.)
Stocked In: 304L & 316L

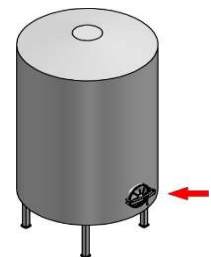

RECTANGULAR MANWAYS
ZORZINI MODEL 166

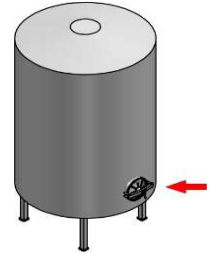

Description	Rectangular Manwaydoor, Opening Outwards
Model No.:	166
Dimensions:	440mm x 332mm (17.5" x 13.0")
Weld Neck Length:	100mm (3.93")
Working Pressure:	0.5 BAR (7.25 PSI)
Handle Type:	V1/165/A
Gasket Material:	EPDM - G/R165
Weight:	18.0 kg (39.7 lb.)
Stocked In:	304L & 316L

ZORZINI MODEL 1500

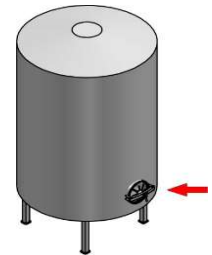

Description	Rectangular Manwaydoor, Opening Outwards
Model No.:	1500
Dimensions:	432mm x 555mm (17.0" x 21.5")
Weld Neck Length:	60mm (2.36")
Working Pressure:	1.0 BAR (14.5 PSI)
Handle Type:	V1/165/A
Gasket Material:	EPDM - G/1500
Weight:	24.0 kg (52.9 lb.)
Stocked In:	304L & 316L

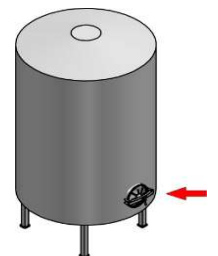
ZORZINI MODEL 1502

Description	Rectangular Manwaydoor, Opening Outwards
Model No.:	1502
Dimensions:	432mm x 555mm (17.0" x 21.5")
Weld Neck Length:	100mm (3.93")
Working Pressure:	1.0 BAR (14.5 PSI)
Handle Type:	V1/165/A
Gasket Material:	EPDM - G/1500
Weight:	27.2 kg (59.9 lb.)
Stocked In:	304L

ZORZINI MODEL 1600

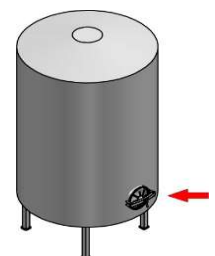
Description	Rectangular Manwaydoor, Opening Outwards
Model No.:	1600
Dimensions:	555mm x 432mm (21.5" x 17.0")
Weld Neck Length:	60mm (2.36")
Working Pressure:	0.8 BAR (11.6 PSI)
Handle Type:	V1/165/A (ACME Available)
Gasket Material:	EPDM - G/1500
Weight:	24.0 kg (52.9 lb.)
Stocked In:	304L



RECTANGULAR MANWAYS

ZORZINI MODEL 1601



Description Rectangular Manwaydoor, Opening Outwards
Model No.: 1601
Dimensions: 555mm x 432mm (21.5" x 17.0")
Weld Neck Length: 80mm (3.14")
Working Pressure: 0.8 BAR (11.6 PSI)
Handle Type: V1/165/A (ACME Available)
Gasket Material: EPDM - G/1500
Weight: 26.0 kg (57.3 lb.)
Stocked In: 304L

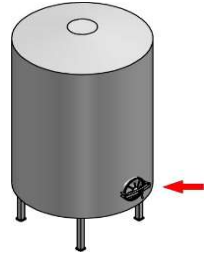

ZORZINI MODEL 1602



Description Rectangular Manwaydoor, Opening Outwards
Model No.: 1602
Dimensions: 555mm x 432mm (21.5" x 17.0")
Weld Neck Length: 100mm (3.93")
Working Pressure: 0.8 BAR (11.6 PSI)
Handle Type: V1/165/A (ACME Available)
Gasket Material: EPDM - G/1500
Weight: 27.2 kg (59.9 lb.)
Stocked In: 304L & 316L

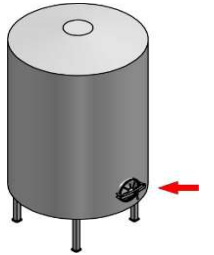

ZORZINI MODEL 1603



Description Rectangular Manwaydoor, Opening Outwards
Model No.: 1603
Dimensions: 555mm x 432mm (21.5" x 17.0")
Weld Neck Length: 150mm (5.90")
Working Pressure: 0.8 BAR (11.6 PSI)
Handle Type: V1/165/A - ACME
Gasket Material: EPDM - G/1500
Weight: 42.4 kg (93.5 lb.)
Stocked In: 304L

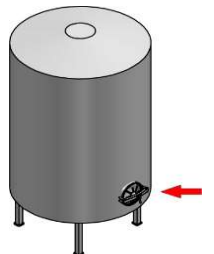

ZORZINI MODEL 1702



Description Rectangular Manwaydoor, Opening Outwards
Model No.: 1702
Dimensions: 555mm x 432mm (21.5" x 17.0")
Weld Neck Length: 100mm (3.93")
Working Pressure: 1.0 BAR (14.5 PSI)
Handle Type: V1/165/A
Gasket Material: EPDM - G/1500
Weight: 28.0 kg (61.7 lb.)
Stocked In: 304L

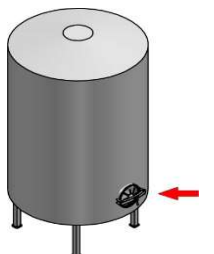

8" TOP ROUND MANWAYS
ZORZINI MODEL 230

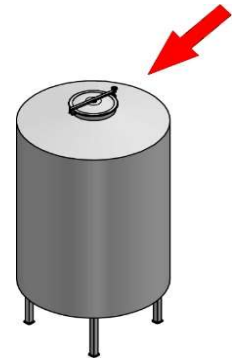

Description	Round Manhole Cover
Model No.:	230
Dimensions:	202mm (8.0")
Weld Neck Length:	85mm (3.34")
Working Pressure:	0.4 BAR (5.80 PSI)
Handle Type:	MEC/60
Gasket Material:	EPDM - G/P200
Weight:	2.4 kg (5.3 lb.)
Stocked In:	304L

ZORZINI MODEL 235

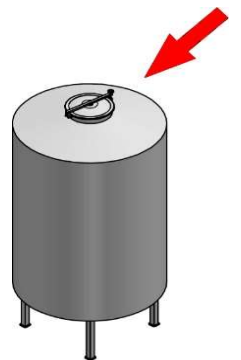

Description	Round Manhole Cover
Model No.:	235
Dimensions:	202mm (8.0")
Weld Neck Length:	85mm (3.34")
Working Pressure:	0.6 BAR (8.70 PSI)
Handle Type:	MEC/60 (3 Handle)
Gasket Material:	EPDM - G/P200
Weight:	3.0 kg (6.6 lb.)
Stocked In:	304L

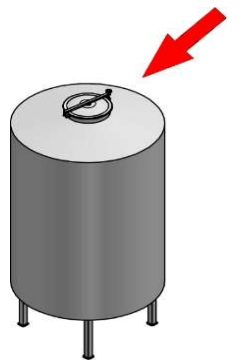
ZORZINI MODEL N/230

Description	Round Manhole Cover
Model No.:	N/230
Dimensions:	202mm (8.0")
Weld Neck Length:	85mm (3.34")
Working Pressure:	0.4 BAR (5.80 PSI)
Handle Type:	MEC/60
Gasket Material:	EPDM - G/T200
Weight:	2.8 kg (6.1 lb.)
Stocked In:	304L & 316L

ZORZINI MODEL T1/200

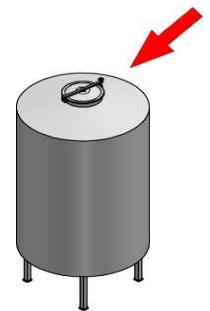
Description	Round Manhole Cover - Back & Side Swing Open
Model No.:	T1/200
Dimensions:	202mm (8.0")
Weld Neck Length:	85mm (3.34")
Working Pressure:	0.4 BAR (5.80 PSI)
Handle Type:	MEC/60
Gasket Material:	EPDM - G/T200
Weight:	2.8 kg (6.1 lb.)
Stocked In:	304L



12" TOP ROUND MANWAYS

ZORZINI MODEL 240



Description Round Manhole Cover
Model No.: 240
Dimensions: 306mm (12.0")
Weld Neck Length: 65mm (2.55")
Working Pressure: 0.1 BAR (1.40 PSI)
Handle Type: MEC/60
Gasket Material: EPDM - G/TR300
Weight: 3.3 kg (7.3 lb.)
Stocked In: 304L

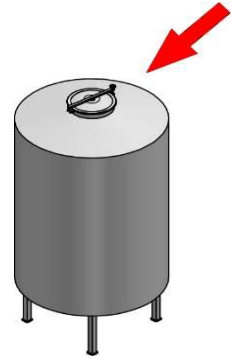

ZORZINI MODEL 241



Description Round Manhole Cover
Model No.: 241
Dimensions: 306mm (12.0")
Weld Neck Length: 100mm (3.93")
Working Pressure: 0.1 BAR (1.40 PSI)
Handle Type: MEC/60
Gasket Material: EPDM - G/TR300
Weight: 3.7 kg (8.1 lb.)
Stocked In: 304L

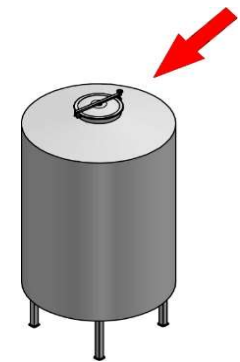

ZORZINI MODEL T1/300



Description Round Manhole Cover - Back & Side Swing Open
Model No.: T1/300
Dimensions: 306mm (12.0")
Weld Neck Length: 65mm (2.55")
Working Pressure: 0.1 BAR (1.40 PSI)
Handle Type: MEC/60
Gasket Material: EPDM - G/T300
Weight: 3.4 kg (7.5 lb.)
Stocked In: 304L & 316L

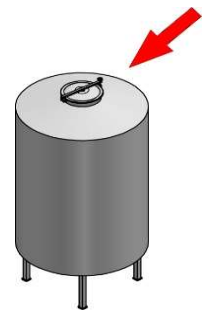

ZORZINI MODEL T1/301



Description Round Manhole Cover - Back & Side Swing Open
Model No.: T1/301
Dimensions: 306mm (12.0")
Weld Neck Length: 100mm (3.93")
Working Pressure: 0.1BAR (1.40PSI)
Handle Type: MEC/60
Gasket Material: EPDM - G/T300
Weight: 3.8 kg (8.4 lb.)
Stocked In: 304L & 316L

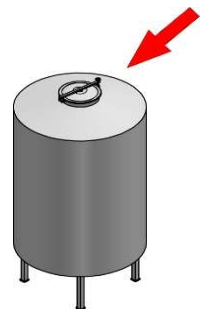

16" TOP ROUND MANWAYS
ZORZINI MODEL 250

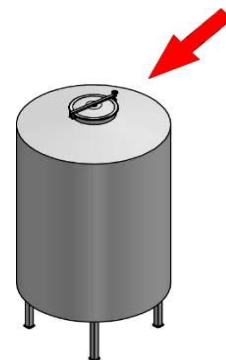

Description	Round Manhole Cover
Model No.:	250
Dimensions:	404mm (16.0")
Weld Neck Length:	65mm (2.55")
Working Pressure:	0.0 BAR / PSI
Handle Type:	MEC/60
Gasket Material:	EPDM - G/AE
Weight:	4.8kg (10.6 lb.)
Stocked In:	304L

ZORZINI MODEL N/240

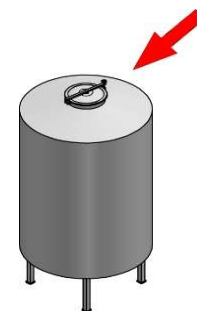

Description	Round Manhole Cover - Back & Side Swing Open
Model No.:	N/240
Dimensions:	404mm (16.0")
Weld Neck Length:	65mm (2.55")
Working Pressure:	0.0 BAR / PSI
Handle Type:	MEC/60
Gasket Material:	EPDM - G/NL250
Weight:	5.6 kg (12.3 lb.)
Stocked In:	304L

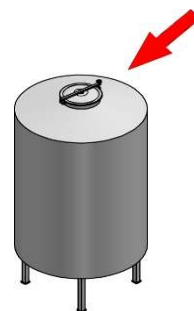
ZORZINI MODEL N/250

Description	Round Manhole Cover - Back & Side Swing Open
Model No.:	N/250
Dimensions:	404mm (16.0")
Weld Neck Length:	65mm (2.55")
Working Pressure:	0.0 BAR / PSI
Handle Type:	MEC/60
Gasket Material:	EPDM - G/AE
Weight:	5.0 kg (11.0 lb.)
Stocked In:	304L & 316L

ZORZINI MODEL NL/250

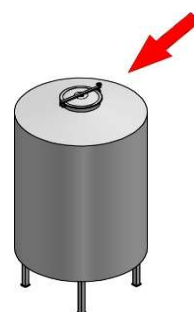
Description	Round Manhole Cover with Clamp Closing
Model No.:	NL/250
Dimensions:	404mm (16.0")
Weld Neck Length:	65mm (2.55")
Working Pressure:	1.0 BAR (14.5 PSI)
Handle Type:	Clamp
Gasket Material:	EPDM - G/NL250
Weight:	6.7 kg (14.8 lb.)
Stocked In:	304L & 316L



16" TOP ROUND MANWAYS

ZORZINI MODEL TV/400



Description	Round Manhole Cover - Back & Side Swing Open
Model No.:	TV/400
Dimensions:	404mm (16.0")
Weld Neck Length:	65mm (2.55")
Working Pressure:	0.0 BAR / PSI
Handle Type:	MEC/60
Gasket Material:	EPDM - G/T400
Weight:	5.6 kg (12.3 lb.)
Stocked In:	304L & 316L

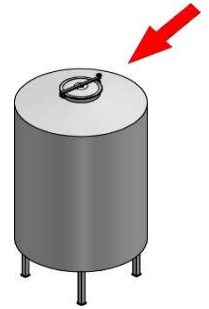

ZORZINI MODEL TV/401



Description	Round Manhole Cover - Back & Side Swing Open
Model No.:	TV/401
Dimensions:	404mm (16.0")
Weld Neck Length:	100mm (3.93")
Working Pressure:	0.0 BAR / PSI
Handle Type:	MEC/60
Gasket Material:	EPDM - G/T400
Weight:	6.3 kg (13.9 lb.)
Stocked In:	304L

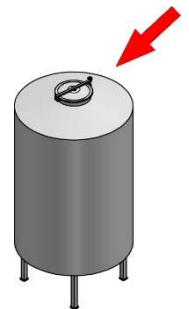

ZORZINI MODEL T1/400 & T1/401



Description	Round Manhole Cover - Back & Side Swing Open
Model No.:	T1/400 & T1/401
Dimensions:	404mm (16.0")
Weld Neck Length:	65mm / 100mm (2.55") / (3.93")
Working Pressure:	0.0 BAR / PSI
Handle Type:	MEC/80 INOX-SS → 
Gasket Material:	EPDM - G/T400
Weight:	5.7 / 6.4 kg (12.6 / 14.1 lb.)
Stocked In:	T1/400 304L --- T1/401 304L & 316L

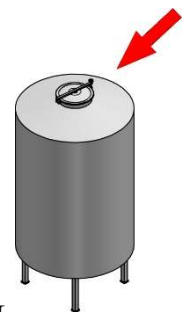

ZORZINI MODEL 6V/250



Description	Round Manhole Cover - Back & Side Swing Open
Model No.:	6V/250
Dimensions:	405mm (16.0")
Weld Neck Length:	65mm (2.55")
Working Pressure:	1.2 BAR (17.40 PSI)
Handle Type:	MEC/60 (6 Handles)
Gasket Material:	EPDM - G/6V250
Weight:	7.9 kg (17.4 lb.)
Stocked In:	304L & 316L

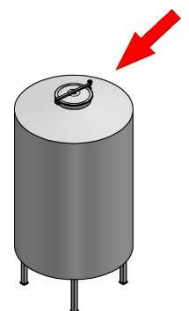

18" TOP ROUND MANWAYS
ZORZINI MODEL TV/450

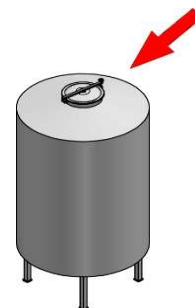

Description	Round Manhole Cover - Back & Side Swing Open
Model No.:	TV/450
Dimensions:	454 mm (18.0")
Weld Neck Length:	100mm (3.93")
Working Pressure:	0.0 BAR / PSI
Handle Type:	MEC/80/A
Gasket Material:	EPDM - G/T450
Weight:	12.2 kg (26.9 lb.)
Stocked In:	304L & 316L

ZORZINI MODEL T1/450

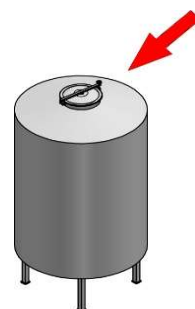

Description	Round Manhole Cover - Back & Side Swing Open
Model No.:	T1/450
Dimensions:	454 mm (18.0")
Weld Neck Length:	100mm (3.93")
Working Pressure:	0.0 BAR / PSI
Handle Type:	MEC/80-INOX-SS
Gasket Material:	EPDM - G/T450
Weight:	11.0 kg (24.2 lb.)
Stocked In:	304L & 316L

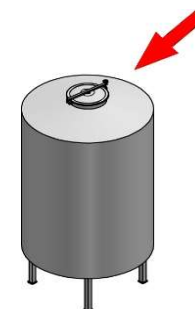
ZORZINI MODEL T/450

Description	Round Manhole Cover with Back Side Opening
Model No.:	T/450
Dimensions:	454 mm (18.0")
Weld Neck Length:	100mm (3.93")
Working Pressure:	0.1 BAR (1.40 PSI)
Handle Type:	V/1/165/A
Gasket Material:	EPDM - G/T450
Weight:	12.2 kg (26.9 lb.)
Stocked In:	304L & 316L

ZORZINI MODEL 5V/450

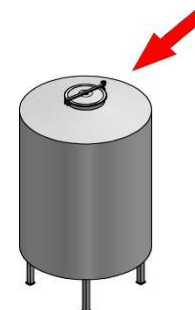
Description	Round Manhole Cover with Back Side Opening
Model No.:	5V/450
Dimensions:	454 mm (18.0")
Weld Neck Length:	100mm (3.93")
Working Pressure:	0.5 BAR (7.25 PSI)
Handle Type:	MEC/60
Gasket Material:	EPDM - G/T450
Weight:	10.0 kg (22.0 lb.)
Stocked In:	304L & 316L



20" TOP ROUND MANWAYS

ZORZINI MODEL N/270



Description	Round Manhole Cover - Back & Side Swing Open
Model No.:	N/270
Dimensions:	518mm (20.0")
Weld Neck Length:	75mm (2.95")
Working Pressure:	0.1 BAR (1.40 PSI)
Handle Type:	MEC/80/AEPDM -
Gasket Material:	G/TR50012.0 kg
Weight:	(26.4 lb.)
Stocked In:	304L

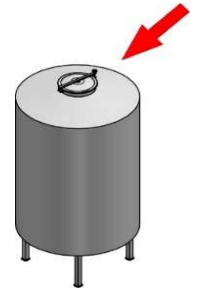

ZORZINI MODEL TV/500



Description	Round Manhole Cover - Back & Side Swing Open
Model No.:	TV/500
Dimensions:	518mm (20.0")
Weld Neck Length:	100mm (3.93")
Working Pressure:	0.0 BAR / PSI
Handle Type:	MEC/80/A
Gasket Material:	EPDM - G/T500
Weight:	14.4 kg (31.7 lb.)
Stocked In:	304L & 316L

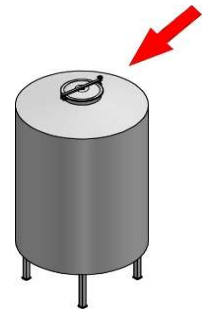

ZORZINI MODEL T1/500



Description	Round Manhole Cover - Back & Side Swing Open
Model No.:	T1/500
Dimensions:	518mm (20.0")
Weld Neck Length:	100mm (3.93")
Working Pressure:	0.0 BAR / PSI
Handle Type:	MEC/80-INOX-SS → 
Gasket Material:	EPDM - G/T500
Weight:	14.8 kg (32.6 lb.)
Stocked In:	304L & 316L

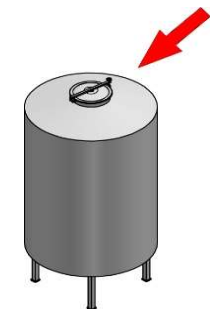

ZORZINI MODEL T/500



Description	Round Manhole Cover - Back & Side Swing Open
Model No.:	T/500
Dimensions:	518mm (20.0")
Weld Neck Length:	100mm (3.93")
Working Pressure:	0.1 BAR (1.40 PSI)
Handle Type:	V1/165/A
Gasket Material:	EPDM - G/T500
Weight:	16.2 kg (35.7 lb.)
Stocked In:	304L & 316L

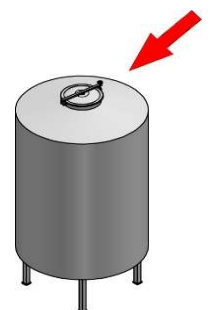

20" TOP ROUND MANWAYS**ZORZINI MODEL 6V/500**

Description	Round Manhole Cover with Back Side Opening
Model No.:	6V/500
Dimensions:	518mm (20.0")
Weld Neck Length:	100mm (3.93")
Working Pressure:	0.5 BAR (7.25 PSI)
Handle Type:	MEC/60
Gasket Material:	EPDM - G/T500
Weight:	12.3 kg (27.1 lb.)
Stocked In:	304L

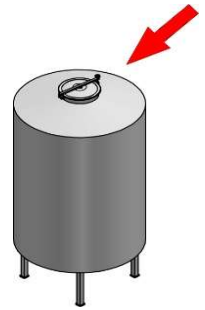

24" TOP ROUND MANWAYS

ZORZINI MODEL TV/600



Description Round Manhole Cover with Back Side Opening
Model No.: TV/600
Dimensions: 620mm (24.0")
Weld Neck Length: 100mm (3.93")
Working Pressure: 0.0 BAR / PSI
Handle Type: MEC/80/A
Gasket Material: EPDM - G/T600
Weight: 18.8 kg (41.4 lb.)
Stocked In: 304L & 316L



ZORZINI MODEL T1/600



Description Round Manhole Cover with Back Side Opening
Model No.: T1/600
Dimensions: 620mm (24.0")
Weld Neck Length: 100mm (3.93")
Working Pressure: 0.0 BAR / PSI
Handle Type: **MEC/80-INOX-SS**
Gasket Material: EPDM - G/T600
Weight: 23.0 kg (50.7 lb.)
Stocked In: 304L & 316L



ZORZINI MODEL T/600



Description Round Manhole Cover with Back Side Opening
Model No.: T/600
Dimensions: 620mm (24.0")
Weld Neck Length: 100mm (3.93")
Working Pressure: 0.0 BAR / PSI
Handle Type: V1/165/A
Gasket Material: EPDM - G/T600
Weight: 21.0 kg (46.3 lb.)
Stocked In: 304L & 316L

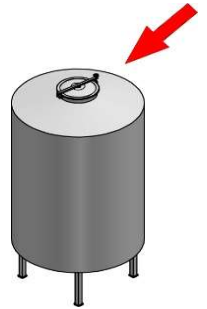

ZORZINI MODEL 8V/600



Description Round Manhole Cover with Back Side Opening
Model No.: 8V/600
Dimensions: 620mm (24.0")
Weld Neck Length: 100mm (3.93")
Working Pressure: 0.2BAR (2.90 PSI)
Handle Type: MEC/60
Gasket Material: EPDM - G/T600
Weight: 19.2 kg (42.3 lb.)
Stocked In: 304L & 316L

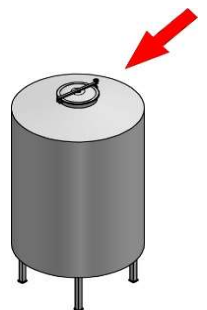

31.5" TOP ROUND MANWAYS
ZORZINI MODEL T1/800

Description	Round Manhole Cover with Back Side Opening
Model No.:	T1/800
Dimensions:	805mm (31.5")
Weld Neck Length:	100mm (3.93")
Working Pressure:	0.0 BAR / PSI
Handle Type:	V1/165/A
Gasket Material:	EPDM - G/800
Weight:	27.4 kg (60.4 lb.)
Stocked In:	304L

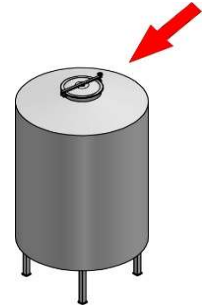
ZORZINI MODEL 10V/800

Description	Round Manhole Cover - Back & Side Swing Open
Model No.:	10V/800
Dimensions:	805mm (31.5")
Weld Neck Length:	105mm (4.13")
Working Pressure:	0.2BAR (2.90PSI)
Handle Type:	MEC/80
Gasket Material:	EPDM - G/800
Weight:	30.5 kg (67.2 lb.)
Stocked In:	304L

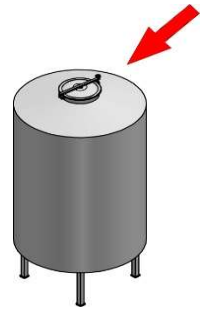

LAVEGGI MANWAYS

**LIMITED SUPPLY
ONLY WHILE SUPPLIES LAST**

LAVEGGI MODEL D14-900



Description	Round Manhole Cover with Back Side Opening
Model No.:	D14
Dimensions:	900mm (35.4")
Weld Neck Length:	100mm (3.93")
Working Pressure:	-0.8/0.3BAR (-11.6/4.35PSI)
Handle Type:	Black Nylon Knob x 8
Gasket Material:	Natural Rubber
Weight:	38.0 kg (83.7 lb.)
Stocked In:	304L

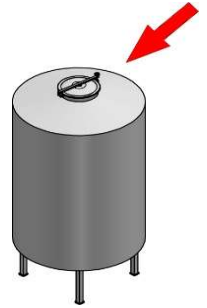

LAVEGGI MODEL D14-1200



Description	Round Manhole Cover with Back Side Opening
Model No.:	D14
Dimensions:	1200mm (47.2")
Weld Neck Length:	100mm (3.93")
Working Pressure:	-0.8/0.3BAR (-11.6/4.35PSI)
Handle Type:	Black Nylon Knob x 10
Gasket Material:	Natural Rubber
Weight:	50.0 kg (110.0 lb.)
Stocked In:	304L



TOP GLASS MANWAY

ZORZINI MODEL T1/G400



Description	Manhole Cover - Glass Lid - Back Side Opening
Model No.:	T1/G400
Dimensions:	404mm (16.0")
Weld Neck Length:	65mm (2.55")
Working Pressure:	0.0 BAR / PSI
Handle Type:	V1/295
Gasket Material:	EPDM - G/T400
Weight:	9.3 kg (20.5 lb.)
Stocked In:	304L

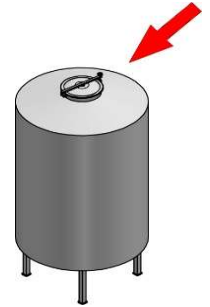

ZORZINI MODEL T1/G450



Description	Manhole Cover - Glass Lid - Back Side Opening
Model No.:	T1/G450
Dimensions:	454 mm (18.0")
Weld Neck Length:	100mm (3.93")
Working Pressure:	0.0 BAR / PSI
Handle Type:	V1/165/A
Gasket Material:	EPDM - G/T450
Weight:	11.9 kg (26.2 lb.)
Stocked In:	304L

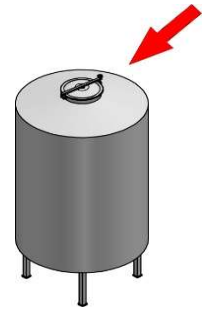

ZORZINI MODEL T1/G500



Description	Manhole Cover - Glass Lid - Back Side Opening
Model No.:	T1/G500
Dimensions:	518mm (20.0")
Weld Neck Length:	100mm (3.93")
Working Pressure:	0.0 BAR / PSI
Handle Type:	V1/165/A
Gasket Material:	EPDM - G/T500
Weight:	16.3 kg (35.9 lb.)
Stocked In:	304L

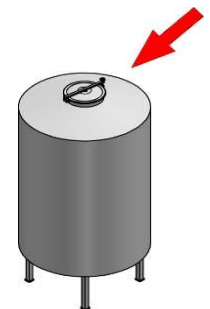

LIGHT PRESSURE MANWAYS
ZORZINI MODEL 300L/E

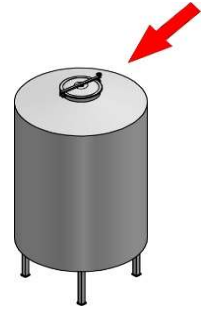

Description	Round LP Manway - Back & Side Swing Opening
Model No.:	300L/E
Dimensions:	323mm (12.70")
Weld Neck Length:	100mm (3.93")
Working Pressure:	-1/2 BAR (-14.5/29.0 PSI)
Handle Type:	MEC/80
Gasket Material:	EPDM - G/300P
Weight:	15.5 kg (34.2 lb.)
Stocked In:	316L

ZORZINI MODEL 400L/E

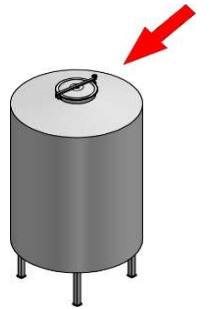

Description	Round LP Manway - Back & Side Swing Opening
Model No.:	400L/E
Dimensions:	422mm (16.6")
Weld Neck Length:	100mm (3.93")
Working Pressure:	-1/2 BAR (-14.5/29.0 PSI)
Handle Type:	MEC/80
Gasket Material:	EPDM - G/400P
Weight:	23.0 kg (50.7 lb.)
Stocked In:	316L

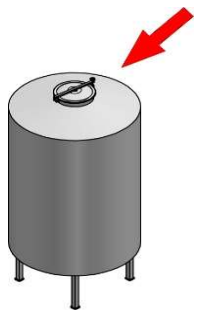
ZORZINI MODEL 450L/E

Description	Round LP Manway - Back & Side Swing Opening
Model No.:	450L/E
Dimensions:	454mm (18.0")
Weld Neck Length:	100mm (3.93")
Working Pressure:	-1/2 BAR (-14.5/29.0 PSI)
Handle Type:	MEC/80
Gasket Material:	EPDM - G/450P
Weight:	28.8 kg (63.5 lb.)
Stocked In:	316L

ZORZINI MODEL 500L/E

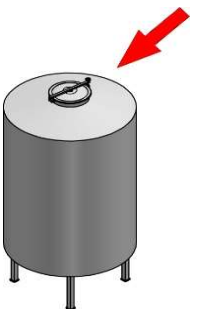
Description	Round LP Manway - Back & Side Swing Opening
Model No.:	500L/E
Dimensions:	527mm (20.74")
Weld Neck Length:	100mm (3.93")
Working Pressure:	-1/2 BAR (-14.5/29.0 PSI)
Handle Type:	MEC/80
Gasket Material:	EPDM - G/500P
Weight:	33.8 kg (74.5 lb.)
Stocked In:	316L



LIGHT PRESSURE MANWAYS

ZORZINI MODEL 600L/E



Description	Round LP Manway - Back & Side Swing Opening
Model No.:	600L/E
Dimensions:	626mm (24.44")
Weld Neck Length:	100mm (3.93")
Working Pressure:	-1/2 BAR (-14.5/29.0 PSI)
Handle Type:	MEC/80
Gasket Material:	EPDM - G/600P
Weight:	41.3 kg (91.0 lb.)
Stocked In:	316L

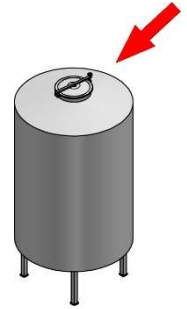

mod. GRI/F



Wire safety grid for manhole covers, in AISI316L

Available for 200 (*), 300 (*), 400, 450, 500, 600 mm diameters.
Designed to support weights not exceeding 20kg
Available also with mounting kit.

Mod.	ØA
200*	190
300*	298
400	390
450	445
500	498
600	598

(*) On request

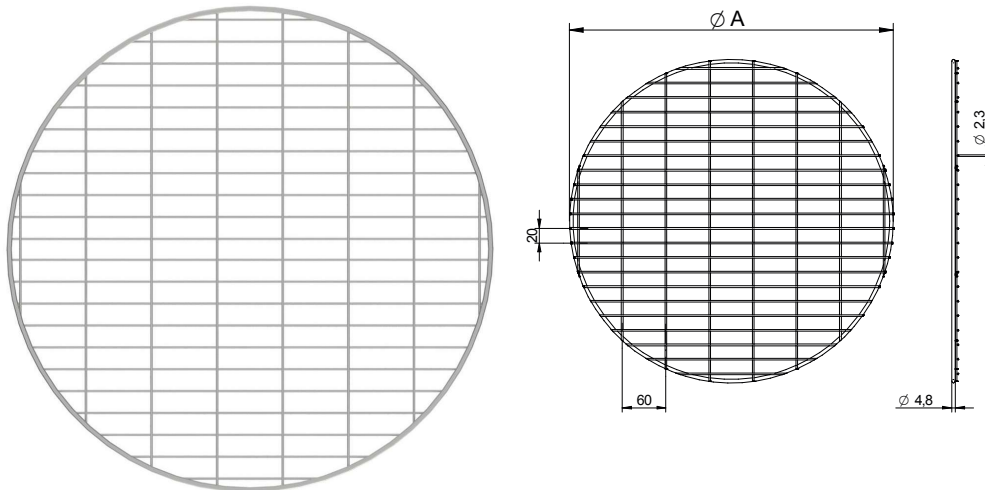

mod. GRI/L



Laser-cut safety grid for manhole covers, in AISI316L

Available for 200, 300, 400, 450, 500, 600 mm diameters. Designed to support weights not exceeding 20kg.
Available also with mounting kit.

Mod.	ØA	Sp.
200	190	1,5
300	296	1,5
400	390	1,5
450	436	1,5
500	500	2
60		

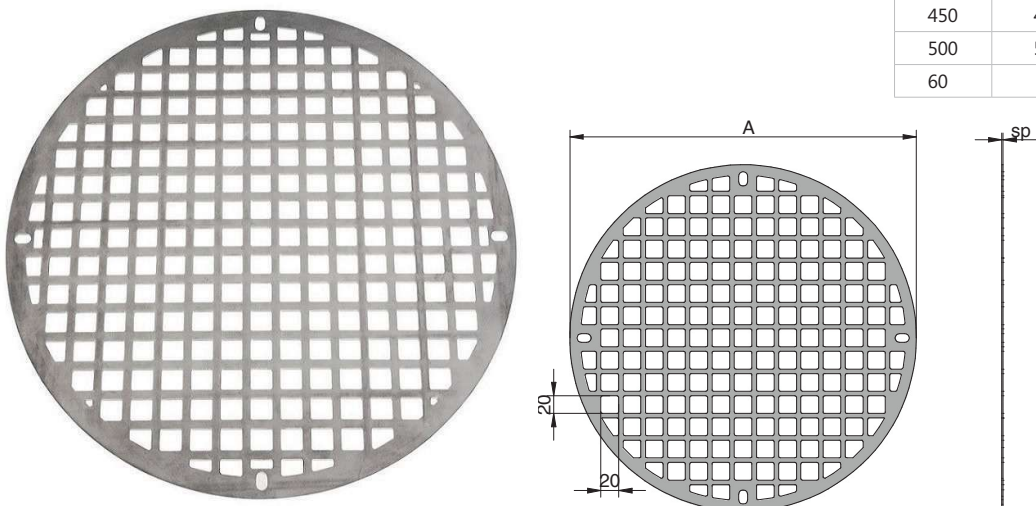





MANWAYS INTERNAL ROUGHNESS		
MOD.	COVER Ra	FRAME Ra
170	<0,8	> 3
170L	<0,8	> 3
174/AE	<0,8	>3
180 - 180SN	<0,8	>3
190 - 191	<0,8	> 2
200N	<0,8	> 3
202 - 203	<0,8	>3
206	<0,8	> 3
200LZD	<0,8	> 3
200LZD/C	<0,8	> 3
201/LW	<0,8	> 3
207LZD	<0,8	> 3
201FLT	<0,8	> 3
200PES	<0,8	> 3
630	<0,8	>3
200/R	<0,8	> 3
200/RP	<0,8	> 3
N230/2V	<0,8	<0,8 (1)
210	<0,8	<0,8 (1)
215	<0,8	<0,8 (1)
220	<0,8	> 3
220/E	<0,8	<0,8 (1)
520	<0,8	> 3
Z/175	<0,8	> 3
285	<0,8	> 3
295	<0,8	> 3
160 - 160/2B	<0,8	> 3
165	<0,8	> 3
1500	<0,8	> 3
1600	<0,8	> 3
1603	<0,8	> 3
1700	<0,8	> 3











* Lower values on request
(1) Except for the welding.

MANHOLES INTERNAL ROUGHNESS		
MOD.	COVER Ra	FRAME Ra
230	<0,8	<0,8 (1)
240	<0,8	<0,8 (1)
250	<0,8	<0,8 (1)
270	<0,8	<0,8 (1)
N230	<0,8	<0,8 (1)
N300	<0,8	<0,8 (1)
N240	<0,8	<0,8 (1)
400AZ	<0,8	<0,8 (1)
N250	<0,8	<0,8 (1)
N270	<0,8	<0,8 (1)
NL250N	<0,8	<0,8 (1)
TV400	<0,8	<0,8 (1)
TV450	<0,8	<0,8 (1)
TV500	<0,8	<0,8 (1)
TV600	<0,8	<0,8 (1)
T1/200	<0,8	<0,8 (1)
T1/300	<0,8	<0,8 (1)
T1/400	<0,8	<0,8 (1)
T1/450	<0,8	<0,8 (1)
T1/500	<0,8	<0,8 (1)
T1/600	<0,8	<0,8 (1)
T1A/200	<=0,5	<=0,5
T1A/300	<=0,5	<=0,5
T1A/400	<=0,5	<=0,5
T1A/450	<=0,5	<=0,5
T1A/500	<=0,5	<=0,5
T1A/600	<=0,5	<=0,5
T1/800	<0,8	<0,8 (1)
T400	<0,8	<0,8 (1)
T450	<0,8	<0,8 (1)
T500	<0,8	<0,8 (1)
T600	<0,8	<0,8 (1)
T1/G400	<0,8	<0,8 (1)
T1/G450	<0,8	<0,8 (1)
T1/G500	<0,8	<0,8 (1)
235	<0,8	<0,8 (1)
245	<0,8	<0,8 (1)
255	<0,8	<0,8 (1)
275	<0,8	<0,8 (1)
N240/4V	<0,8	<0,8 (1)
3V/200	<0,8	<0,8 (1)
3V/300	<0,8	<0,8 (1)
4V/400	<0,8	<0,8 (1)
5V/450	<0,8	<0,8 (1)
6V/250N	<0,8	<0,8 (1)
6V/500	<0,8	<0,8 (1)
8V/600	<0,8	<0,8 (1)
10V/800	> 3	< 1
MOD.	COVER Ra	FRAME Ra
300L	< = 0,8	< = 0,6 (1)
400L	< = 0,8	< = 0,6 (1)
450L	< = 0,8	< = 0,6 (1)
500L	< = 0,8	< = 0,6 (1)
600L	< = 0,8	< = 0,6 (1)
300L/E	< = 0,8	< = 0,8 (1)
400L/E	< = 0,8	< = 0,8 (1)
450L/E	< = 0,8	< = 0,8 (1)
500L/E	< = 0,8	< = 0,8 (1)
600L/E	< = 0,8	< = 0,8 (1)
300P	< = 0,8	< = 0,6 (1)
400P	< = 0,8	< = 0,6 (1)
450P	< = 0,8	< = 0,6 (1)
500P	< = 0,8	< = 0,6 (1)
600P	< = 0,8	< = 0,6 (1)





MANWAY HANDLES

HANDLE	PICTURE	PART NO.	DESCRIPTION	MATERIAL	THREAD	DIA.	MANWAY ASSOCIATED
MEC/60		94160	HAND KNOB	NYLON	M10	60MM	215, 230, 235, 240, 250, N/230, N/240, N/250, TV/400, T1/200, T1/300, T1/400, 235, 6V/250, 5V/450, 6V/500, 8V/600
MEC/60/A		94161	HAND KNOB	NYLON	M10	60MM	285, 295
MEC/80		94170	HAND KNOB	NYLON	M14	80MM	170, 174AE, 10/V/800, 300L/E, 400L/E, 450L/E, 500L/E, 600L/E
MEC/80		73069	HAND KNOB	NYLON	M16	80MM	T1/450, T1/500, T1/600, T1/800, T/450, T/500, T/600
MEC/80/A		94171	HAND KNOB	NYLON	M14	80MM	Z/175, N/270, TV/450, TV/500, TV/600
MEC/80SS INOX		94054	HAND KNOB	304SS	M10	80MM	230, 240, 250, N230, N240, N250, TV400, T1/200, T1/300, T1/400
MEC/80SS INOX		94056	HAND KNOB	304SS	M14	80MM	Z/175, N/270, TV/450, TV/500, TV/600, 300L/E, 400L/E, 450L/E, 500L/E, 600L/E
MEC/80SS INOX		94057	HAND KNOB	304SS	M16	80MM	160, 165, 166, 184, 186, T1/450, T1/500, T1/600, T1/800, T/450, T/500, T/600
MEC/150		73041	HANDWHEEL	NYLON	M14	150MM	170, 174/AE, 200RP
MEC/150		94081	HANDWHEEL	NYLON	M16	150MM	184, 186, 200RP, T/450, T/500, T/600
MEC/150/A		73040	HANDWHEEL	NYLON	M16	150MM	520, 160, 165, 166, 1500, 1502, 1600, 1601, 1602

MANWAY HANDLES

HANDLE	PICTURE	PART NO.	DESCRIPTION	MATERIAL	THREAD	DIA.	MANWAY ASSOCIATED
MEC/151		94085	HANDWHEEL	NYLON	16 X 16	150MM	210, 270
MEC/200		73043	HANDWHEEL	NYLON	19 X 19	200MM	220
V1/165		94030	T-HANDLE	304SS	M16		184, 186, 200RP
V1/165A		94029	T-HANDLE W/ BRASS WASHER	304SS	M16		160, 165, 166, 520, 1500, 1502, 1600, 1601, 1602, 1603, 1702, T1/450, T1/500, T1/600, T1/800, T/450, T/500, T/600, T1/G450, T1/G500
V1/165A ACME		94048	T-HANDLE	304SS	ACME		1603 (GSP STOCK)
V1/165K		94032	T-HANDLE	304SS	M16		160, 165, 166
V1/170		94040	T-HANDLE	304SS	M14		170, 174AE, TV/450, TV/500, TV/600, 10V/800, 300L/E, 400L/E, 450L/E, 500L/E, 600L/E
V1/Z175A		94021	T-HANDLE	304SS	M14		Z/175, 295, N/270, TV/450, TV/500, TV/600
V1/Z175K		94022	T-HANDLE	304SS	M14		Z/175, TV400, TV450, TV500, TV600
V1/190		94044	T-HANDLE	304SS	M20		190, 191, 203, 201-LZD, 200/R
V1/200		94030	T-HANDLE	304SS	M10		220

MANWAY HANDLES

HANDLE	PICTURE	PART NO.	DESCRIPTION	MATERIAL	THREAD	DIA.	MANWAY ASSOCIATED
V1/260		94046	T-HANDLE	304SS	M24		630,631
V1/295		94010	T-HANDLE	304SS	M10		230, 235, 240, 250, N230, N240, N250 5V/450, 6V/250, 6V/500, TV400, T1/200, T1/300, T1/400, T1/G400
V1/295A		94011	T-HANDLE	304SS	M10		285 / 295
V1/295K		94012	T-HANDLE	304SS	M10		285 / 295

mod. G/170

Gasket for models:
170, 174/AE, 180, 14/L

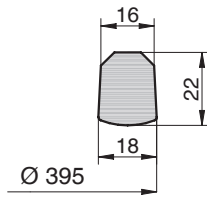

NEW VERSION			
CODE	COMPOUND	COLOR	Temperature
96210	NBR	WHITE RAL 9016	-30°/110°C
96211	EPDM	GREY RAL 7040	-15°/90°C
96215	SILICONE	TRANSPARENT WHITE	-50°/200°C
96216	FPM	BLACK RAL 9017	-10°/250°C

mod. G/EL

Gasket

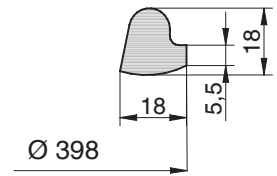

OLD VERSION UNTIL AL 05/2002			
CODE	COMPOUND	COLOR	Temperature
96080	NBR	WHITE RAL 9016	-30°/110°C
96081	EPDM	GREY RAL 7040	-15°/90°C
96085	SILICONE	TRANSPARENT WHITE	-50°/200°C
96086	FPM	BLACK RAL 9017	-10°/250°C

mod. G/15

Gasket for models:
200N-202-203

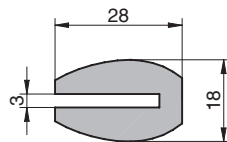

CODE	COMPOUND	COLOR	Temperature
96000	NBR	WHITE RAL 9016	-30° / 110°C
96001	EPDM	GREY RAL 7040	-15° / 90°C
96005	SILICONE	TRANSPARENT WHITE	-50° / 200°C
96006	FPM	BLACK RAL 9017	-10° / 250°C

mod. G/480

Gasket for models:
190, 191,201LW

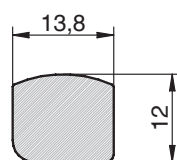

CODE	COMPOUND	COLOR	Temperature
96460	NBR	WHITE RAL 9016	-30° / 110°C
96461	EPDM	GREY RAL 7040	-15° / 90°C
96465	SILICONE	TRANSPARENT WHITE	-50° / 200°C
96466	FPM	BLACK RAL 9017	-10° / 250°C

mod. G/200LZD



Gasket for models:
200LZD, 200LZD/C

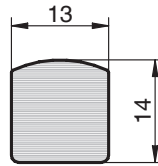

CODE	COMPOUND	COLOR	Temperature
96040	NBR	WHITE RAL 9016	-30° / 110°C
96041	EPDM	GREY RAL 7040	-15° / 90°C
96045	SILICONE	TRANSPARENT WHITE	-50° / 200°C
96046	FPM	BLACK RAL 9017	-10° / 250°C

mod. G/200PES



Gasket for models:
200PES, 200PES pivot

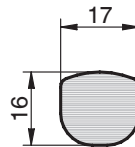

CODE	COMPOUND	COLOR	Temperature
96457	EPDM	DARK GREY	-15° / 90°C
96456	FPM	BLACK RAL 9017	-10° / 250°C

mod. G/630



Gasket for models:
630

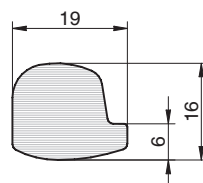

CODE	COMPOUND	COLOR	Temperature
96490	NBR	WHITE RAL 9016	-30° / 110°C
96498	EPDM	GREY RAL 7040	-15° / 90°C
96495	SILICONE	TRANSPARENT WHITE	-50° / 200°C
96496	FPM	BLACK RAL 9017	-10° / 250°C

mod. G/200R



Gasket for models:
200R

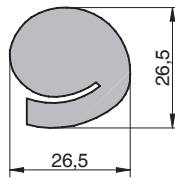

CODE	COMPOUND	COLOR	Temperature
96050	NBR	WHITE RAL 9016	-30/110°C
96051	EPDM	GREY RAL 7040	-15/90°C
96055	SILICONE	TRANSPARENT WHITE	-50/200°C
96056	FPM	BLACK RAL 9017	-10/250°C

mod. G/200RP



Gasket for models:
200RP

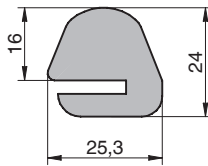

CODE	COMPOUND	COLOR	Temperature
96230	NBR	WHITE RAL 9016	-30/110°C
96231	EPDM	GREY RAL 7040	-15/90°C
96235	SILICONE	TRANSPARENT WHITE	-50/200°C
96236	FPM	BLACK RAL 9017	-10/250°C

mod. G/Z175



Gasket for models:
Z175

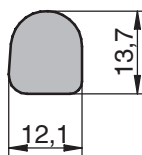

CODE	COMPOUND	COLOR	Temperature
96180	NBR	WHITE RAL 9016	-30/110°C
96181	EPDM	GREY RAL 7040	-15/90°C
96185	SILICONE	TRANSPARENT WHITE	-50/200°C
96186	FPM	BLACK RAL 9017	-10/250°C

mod. G/1500



Gasket for models:
1500, 1500/AI, 1600, 1700, 1400

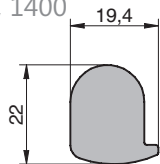

NEW VERSION			
CODE	COMPOUND	COLOR	Temperature
96420	NBR	WHITE RAL 9016	-30/110°C
96421	EPDM	GREY RAL 7040	-15/90°C
96425	SILICONE	TRANSPARENT WHITE	-50/200°C
96426	FPM	BLACK RAL 9017	-10/250°C



Gasket

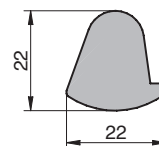

OLD VERSION UNTIL 01/2010			
CODE	COMPOUND	COLOR	Temperature
96030	NBR	WHITE RAL 9016	-30/110°C
96031	EPDM	GREY RAL 7040	-15/90°C
96035	SILICONE	TRANSPARENT WHITE	-50/200°C
96036	FPM	BLACK RAL 9017	-10/250°C

mod. G/295



Gasket for models:
285, 295

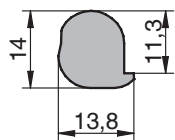

CODE	COMPOUND	COLOR	Temperature
96020	NBR	WHITE RAL 9016	-30/110°C
96021	EPDM	GREY RAL 7040	-15/90°C
96025	SILICONE	TRANSPARENT WHITE	-50/200°C
96026	FPM	BLACK RAL 9017	-10/250°C

mod. G/R165



Gasket for models:
160, 165, 160/2B

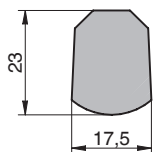

NEW			
CODE	COMPOUND	COLOR	Temperature
96200	NBR	WHITE RAL 9016	-30/110°C
96201	EPDM	GREY RAL 7040	-15/90°C
96205	SILICONE	TRANSPARENT WHITE	-50/200°C
96206	FPM	BLACK RAL 9017	-10/250°C



Gasket

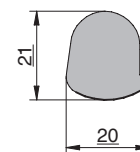

OLD TILL 05/2002			
CODE	COMPOUND	COLOR	Temperature
96090	NBR	WHITE RAL 9016	-30/110°C
96091	EPDM	GREY RAL 7040	-15/90°C
96095	SILICONE	TRANSPARENT WHITE	-50/200°C
96096	FPM	BLACK RAL 9017	-10/250°C

mod. G/P200



Gasket for models:
230, 235, 60

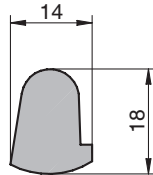

CODE	COMPOUND	COLOR	Temperature
96100	NBR	WHITE RAL 9016	-30/110°C
96101	EPDM	GREY RAL 7040	-15/90°C
96105	SILICONE	TRANSPARENT WHITE	-50/200°C
96106	FPM	BLACK RAL 9017	-10/250°C

mod. G/AE



Gasket for models:
220, 220/E, 250, N/250,
255, 50, 90, 100,
N/100, 110, C/330

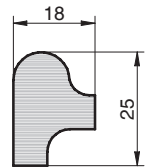
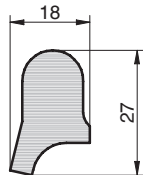

NEW			
CODE	COMPOUND	COLOR	Temperature
96410	NBR	WHITE RAL 9016	-30/110°C
96411	EPDM	GREY RAL 7040	-15/90°C
96415	SILICONE	TRANSPARENT WHITE	-50/200°C
96416	FPM	BLACK RAL 9017	-10/250°C

OLD TILL 09/2009			
CODE	COMPOUND	COLOR	Temperature
96070	NBR	WHITE RAL 9016	-30/110°C
96071	EPDM	GREY RAL 7040	-15/90°C
96075	SILICONE	TRANSPARENT WHITE	-50/200°C
96076	FPM	BLACK RAL 9017	-10/250°C

mod. G/TR300



Gasket for models:
210, 215, 240, 245,
70, 80

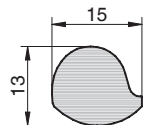
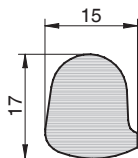

NEW			
CODE	COMPOUND	COLOR	Temperature
96470	NBR	WHITE RAL 9016	-30° / 110°C
96471	EPDM	GREY RAL 7040	-15° / 90°C
96475	SILICONE	TRANSPARENT WHITE	-50° / 200°C
96476	FPM	BLACK RAL 9017	-10° / 250°C

OLD TILL AL 09/2010			
CODE	COMPOUND	COLOR	Temperature
96160	NBR	WHITE RAL 9016	-30/110°C
96161	EPDM	GREY RAL 7040	-15/90°C
96165	SILICONE	TRANSPARENT WHITE	-50/200°C
96166	FPM	BLACK RAL 9017	-10/250°C

mod. G/TR500



Gasket for models:
520, 270, N/270, 275,
150, N/150

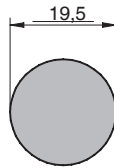

CODE	COMPOUND	COLOR	Temperature
96170	NBR	WHITE RAL 9016	-30° / 110°C
96171	EPDM	GREY RAL 7040	-15° / 90°C
96175	SILICONE	TRANSPARENT WHITE	-50° / 200°C
96176	FPM	BLACK RAL 9017	-10° / 250°C

mod. G/6V250



Gasket for models:
6V/250

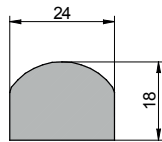

CODE	COMPOUND	COLOR	Temperature
96060	NBR	WHITE RAL 9016	-30/110°C
96061	EPDM	GREY RAL 7040	-15/90°C
96065	SILICONE	TRANSPARENT WHITE	-50/200°C
96066	FPM	BLACK RAL 9017	-10/250°C

mod. G/NL250



Gasket for models:
N/240/4V, N/240, NL/250

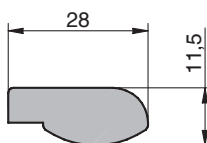

CODE	COMPOUND	COLOR	Temperature
96220	NBR	WHITE RAL 9016	-30/110°C
96221	EPDM	GREY RAL 7040	-15/90°C
96225	SILICONE	TRANSPARENT WHITE	-50°/200°C
96226	FPM	BLACK RAL 9017	-10/250°C

mod. 400AZ/NL



Gasket for models:
400/AZ-NL

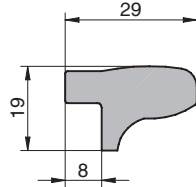

CODE	COMPOUND	COLOR	Temperature
96430	NBR	WHITE RAL 9016	-30/110°C
96431	EPDM	GREY RAL 7040	-15/90°C
96435	SILICONE	TRANSPARENT WHITE	-50/200°C
96436	FPM	BLACK RAL 9017	-10/250°C

mod. 400AZ/GN



Gasket for models:
400/AZ-GN

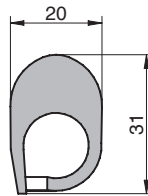

CODE	COMPOUND	COLOR	Temperature
96330	NBR	WHITE RAL 9016	-30/110°C
96331	EPDM	GREY RAL 7040	-15/90°C

mod. G/T200



Gasket for models:
N/230, T1/200, 3V/200

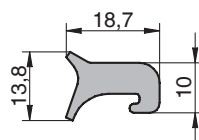

CODE	COMPOUND	COLOR	Temperature
96360	NBR	WHITE RAL 9016	-30/110°C
96361	EPDM	GREY RAL 7040	-15/90°C
96365	SILICONE	TRANSPARENT WHITE	-50/200°C
96366	FPM	BLACK RAL 9017	-10/250°C

mod. G/T300



Gasket for models:
T1/300, 3V/300

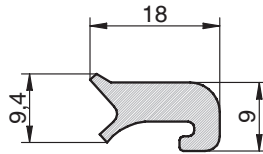

CODE	COMPOUND	COLOR	Temperature
96300	NBR	WHITE RAL 9016	-30/110°C
96301	EPDM	GREY RAL 7040	-15/90°C
96305	SILICONE	TRANSPARENT WHITE	-50/200°C
96306	FPM	BLACK RAL 9017	-10/250°C

mod. G/T400



Gasket for models:
TV/400, T1/400, T1/G400, 4V/400

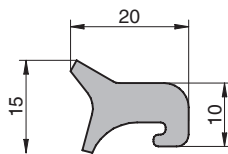

CODE	COMPOUND	COLOR	Temperature
96370	NBR	WHITE RAL 9016	-30/110°C
96371	EPDM	GREY RAL 7040	-15/90°C
96375	SILICONE	TRANSPARENT WHITE	-50/200°C
96376	FPM	BLACK RAL 9017	-10/250°C

mod. G/T450



Gasket for models:
TV/450, T1/450, T/450, T1/G450,
5V/450

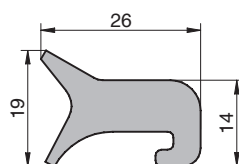

CODE	COMPOUND	COLOR	Temperature
96380	NBR	WHITE RAL 9016	-30/110°C
96381	EPDM	GREY RAL 7040	-15/90°C
96385	SILICONE	TRANSPARENT WHITE	-50/200°C
96386	FPM	BLACK RAL 9017	-10/250°C

mod. G/N300



Gasket for models:
N/300

CODE	COMPOUND	COLOR	Temperature
96340	NBR	WHITE RAL 9016	-30/110°C
96341	EPDM	GREY RAL 7040	-15/90°C
96345	SILICONE	TRANSPARENT WHITE	-50/200°C
96346	FPM	BLACK RAL 9017	-10/250°C

mod. G/T500



Gasket for models:
TV/500, T1/500, T/500, T1/G500,
6V/500

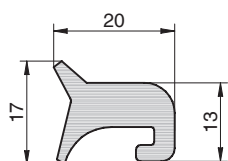

CODE	COMPOUND	COLOR	Temperature
96310	NBR	WHITE RAL 9016	-30° / 110°C
96311	EPDM	GREY RAL 7040	-15° / 90°C
96315	SILICONE	TRANSPARENT WHITE	-50° / 200°C
96316	FPM	BLACK RAL 9017	-10° / 250°C

mod. G/T600



Gasket for models:
TV/600, T1/600, T/600, 8V/600

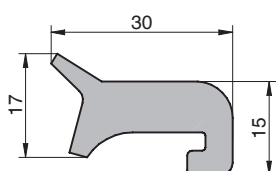

CODE	COMPOUND	COLOR	Temperature
96320	NBR	WHITE RAL 9016	-30/110°C
96321	EPDM	GREY RAL 7040	-15/90°C
96325	SILICONE	TRANSPARENT WHITE	-50/200°C
96326	FPM	BLACK RAL 9017	-10/250°C

mod. G/800



Gasket for models:
T1/800, 10V/800

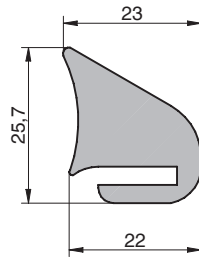

CODE	COMPOUND	COLOR	Temperature
96350	NBR	WHITE RAL 9016	-30/110°C
96351	EPDM	GREY RAL 7040	-15/90°C

mod. G/300P



Gasket for models:
300L-300LE-300P

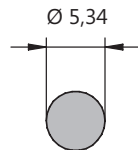

CODE	COMPOUND	COLOR	Temperature
96600	NBR	WHITE RAL 9016	-30° / 110°C
96601	EPDM	GREY RAL 7040	-15° / 90°C
96605	SILICONE	TRANSPARENT WHITE	-50° / 200°C
96606	FPM	BLACK RAL 9017	-10° / 250°C

mod. G/400P



Gasket for models:
400L-400LE-400P

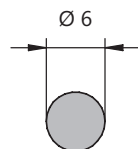

OLD TILL 08-2018			
CODE	COMPOUND	COLOR	Temperature
96250	NBR	WHITE RAL 9016	-30° / 110°C
96251	EPDM	GREY RAL 7040	-15° / 90°C
96255	SILICONE	TRANSPARENT WHITE	-50° / 200°C
96256	FPM	BLACK RAL 9017	-10° / 250°C

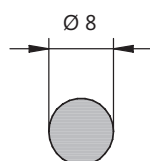

NEW from 08-2018			
CODE	COMPOUND	COLOR	Temperature
96010	NBR	WHITE RAL 9016	-30° / 110°C
96011	EPDM	GREY RAL 7040	-15° / 90°C
96015	SILICONE	TRANSPARENT WHITE	-50° / 200°C
96016	FPM	BLACK RAL 9017	-10° / 250°C

mod. G/450P



Gasket for models:
450L-450LE-450P-201FLT

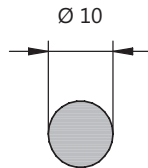

CODE	COMPOUND	COLOR	Temperature
96260	NBR	WHITE RAL 9016	-30° / 110°C
96261	EPDM	GREY RAL 7040	-15° / 90°C
96265	SILICONE	TRANSPARENT WHITE	-50° / 200°C
96266	FPM	BLACK RAL 9017	-10° / 250°C

mod. G/500P



Gasket for models:
500L-500LE-500P

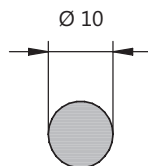

CODE	COMPOUND	COLOR	Temperature
96270	NBR	WHITE RAL 9016	-30/110°C
96271	EPDM	GREY RAL 7040	-15/90°C
96275	SILICONE	TRANSPARENT WHITE	-50/200°C
96276	FPM	BLACK RAL 9017	-10/250°C

mod. G/600P



Gasket for models:
600L-600LE-600P

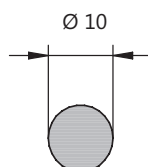

CODE	COMPOUND	COLOR	Temperature
96280	NBR	WHITE RAL 9016	-30° / 110°C
96281	EPDM	GREY RAL 7040	-15° / 90°C
96285	SILICONE	TRANSPARENT WHITE	-50° / 200°C
96286	FPM	BLACK RAL 9017	-10° / 250°C

MANWAY GASKETS:

WE STOCK GREY EPDM FOR ALL MANWAYS LISTED IN CATALOGUE
CAN ALSO PROVIDE GASKETS IN THE FOLLOWING MATERIAL UPON REQUEST:

- SILICON (TRANSPARENT WHITE)
- NBR (WHITE)
- VITON (BLACK)

MANWAY HANDLES:

WE STOCK HANDLES FOR ALL MANWAYS LISTED IN CATALOGUE
OPTIONAL HANDLES FOR MANWAYS CAN BE PROVIDED UPON REQUEST

SPARE PARTS:

WE STOCK A LARGE INVENTORY OF SPARE PARTS FOR ZORZINI MANWAYS.

DOWNLOAD EXPLODED VIEW FROM WEB LINK UNDER PICTURE OF LISTED
MANWAY, OR CONTACT US AND WE CAN ASSIST IN IDENTIFYING THE
REPLACEMENT PART YOU MAY REQUIRE.

NOT SURE WHAT MANWAY YOU HAVE, SEND US A FEW PICTURES OF IT AND
WE WILL HELP YOU IDENTIFY IT AND THE PARTS YOU MAY REQUIRE

GOULD STAINLESS PRODUCTS LTD.
www.gouldstainless.com

CONTACT INFORMATION

For further information, specifications, availability and pricing on items listed in this catalogue please contact us at:

Contact Info:

Toll Free: (866) 477-5831
Phone: (403) 640-2331
E-mail: sales@gouldstainless.com
Web: www.gouldstainless.com

Office / Warehouse:

1141, 6027 - 78th Avenue S.E.
Calgary, AB T2C 5P1
Canada